



QSFP to 4xSFP Converter

40G QSFP to 10G SFP Converting Device
100G QSFP to 25G SFP Converting Device (In Development)



i-COWORKS

www.icoworks.co.kr

Tel : +82-40-824-7283

Fax : +82-40-824-7284

sales@icoworks.co.kr

Description

Optical transceiver compatibility problem solving and optical transmission distance extension solution of optical communication equipment.



CV-Q404S10-R3 (19' RACK Type)



CV-Q404S10-S (Single Type)

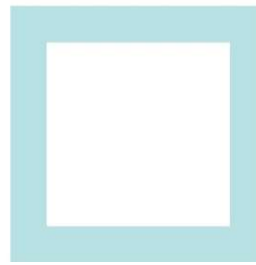

QSFP to 4xSFP Converter

40G QSFP to 10G SFP Converting Device
 100G QSFP to 25G SFP Converting Device (In Development)



Features

- 1xQSFP to 4xSFP Converting Device
 - Single Type or 19' Rack Type
- STANDARDS COMPLIANCE
 - QSFP+ End : SFF-8436 IEEE 802.3ba
 - SFP+ End : SFF-8431 SFF-8432 SFF-8472
- Data Rate Per Lane 9.8Gbps to 11.32Gbps
- With 4ch CDR (clock and data recovery)
- DC -48V supply voltage



CV-Q404S10-R3 (19' RACK Type)



CV-Q404S10-S (Single Type)

Application

- QSFP+ long distance link
- InfiniBand 4X SDR, DDR, QDR and FDR
- Ethernet 10G, 40G
- Fiber Channel 10G, 40G, SAN, 4X16G
- Rack-to-Rack, Shelf-to-Shelf Interconnect
- Top of Rack (TOR) and Core Switch

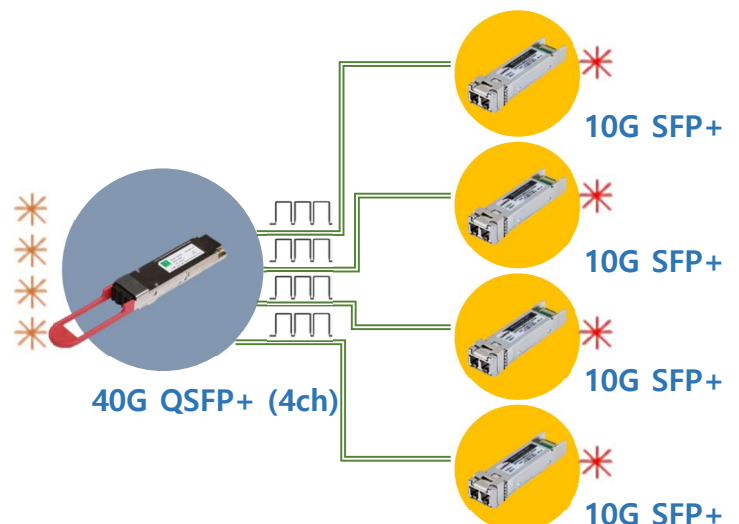

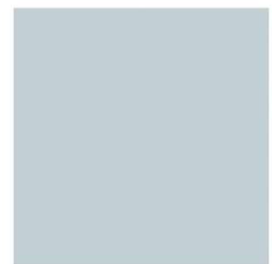

QSFP to 4xSFP Converter

40G QSFP to 10G SFP Converting Device
 100G QSFP to 25G SFP Converting Device (In Development)

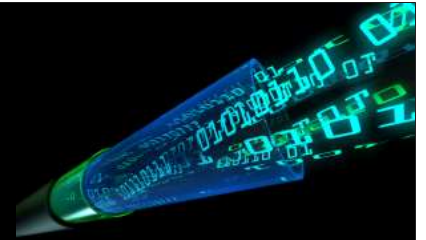

Absolute Maximum Ratings

| Parameters | Symbol | Min | Max. | Units | Conditions |
|-----------------------|--------|-----|------|-------|------------|
| Operating Temperature | Tc | 0 | 70 | °C | Case |
| Storage Temperature | Tstg | -20 | +85 | °C | Ambient |
| Relative Humidity | RH | 5 | 95 | % | |

ELECTRICAL CHARACTERISTICS

| Parameters | Values | | | | Conditions |
|------------------------|--------|------|------|-------|------------|
| | Min. | Typ. | Max | Units | |
| Data Rate Per Lane | 9.8 | | 11.3 | Gbps | With CDR |
| Power Supply | | -48 | | V | DC |
| Power Consumption | | 8 | | W | |
| Differential Impedance | 90 | | 110 | Ω | |

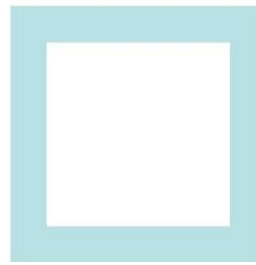

QSFP to 4xSFP Converter

40G QSFP to 10G SFP Converting Device
 100G QSFP to 25G SFP Converting Device (In Development)



TYPICAL CONNECTION

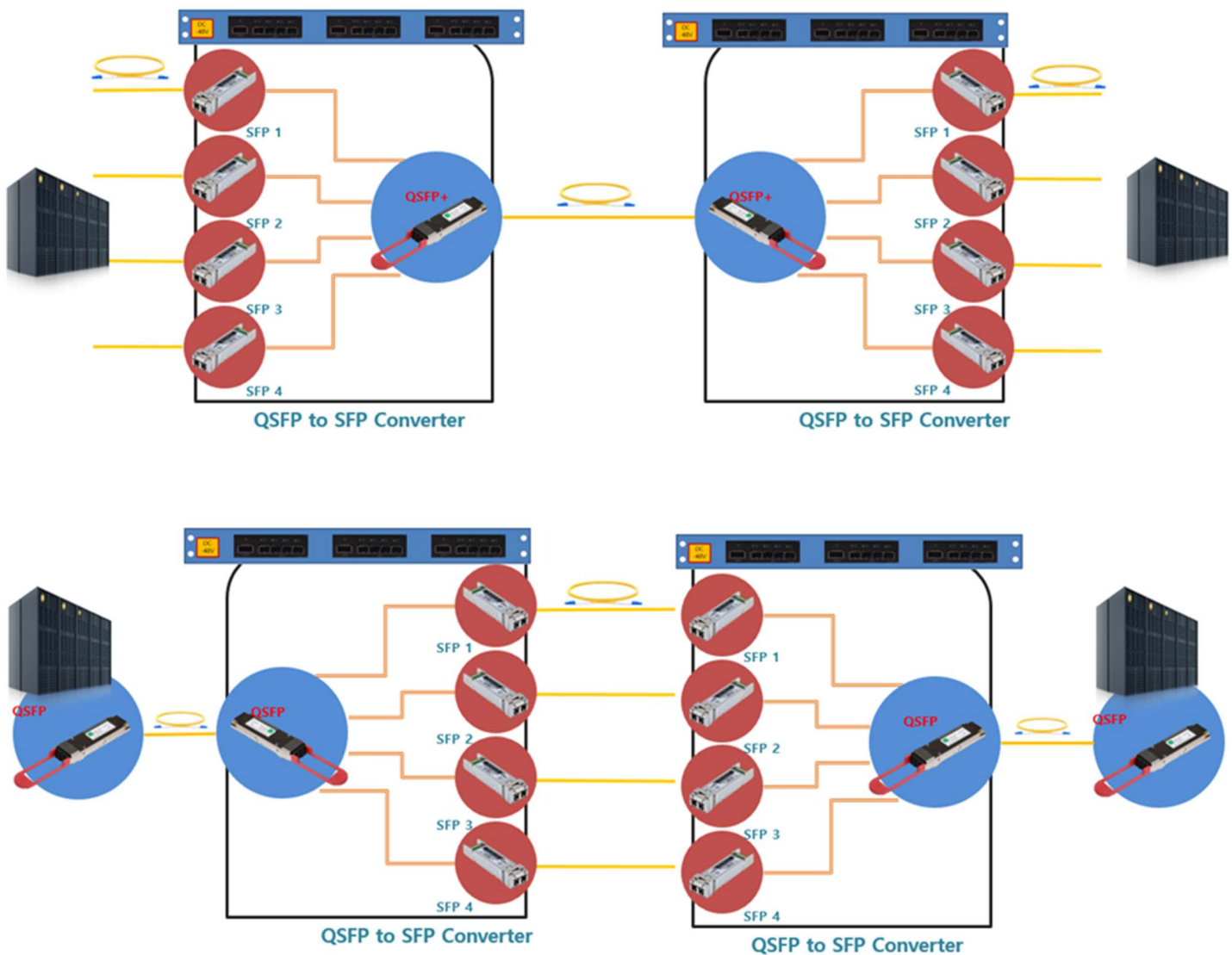

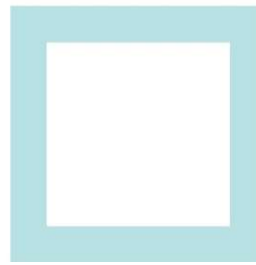

QSFP to 4xSFP Converter

40G QSFP to 10G SFP Converting Device
 100G QSFP to 25G SFP Converting Device (In Development)



MECHANICAL DIMENSION

CV-Q404S10-S (Single Type)

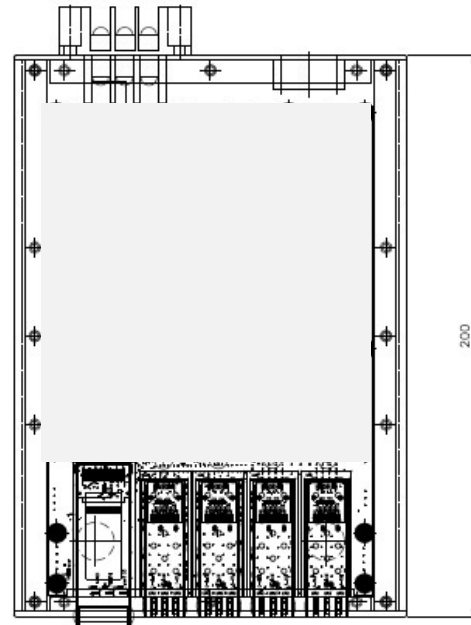
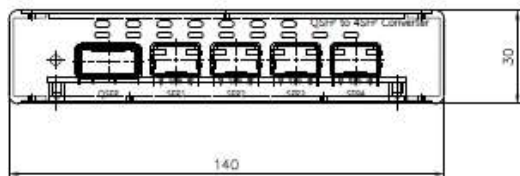

MECHANICAL DIMENSION

CV-Q404S10-R3 (19' RACK Type)

